

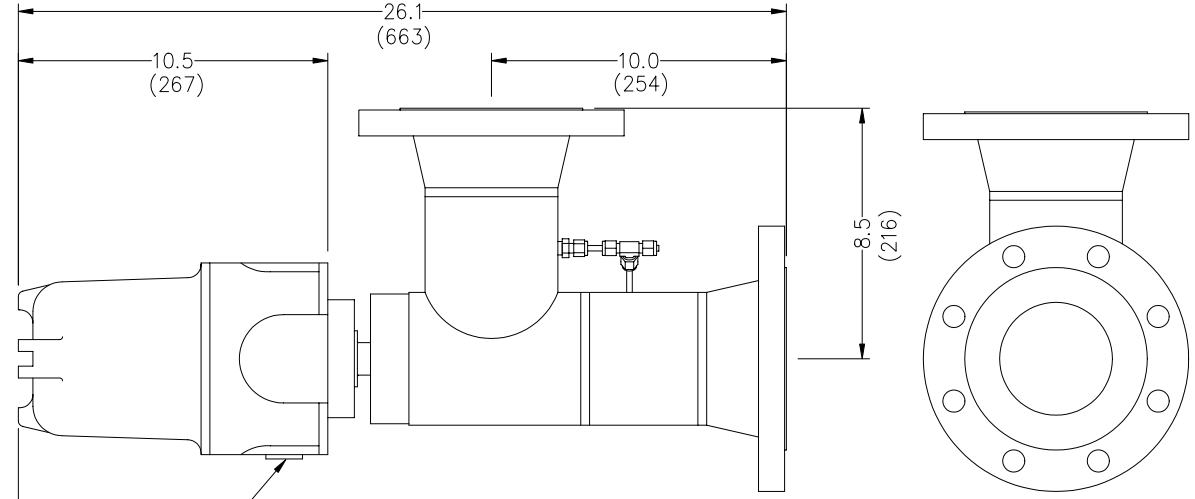

REV	DATE	ECO	COMMENTS
A	06/04/03	169	ADD METRIC UNITS

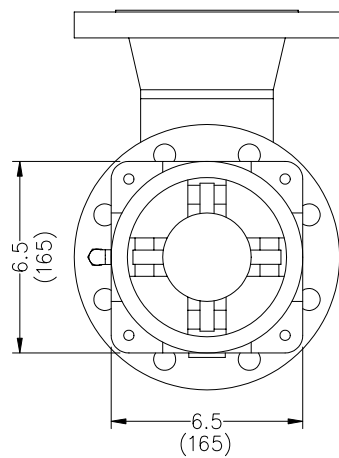
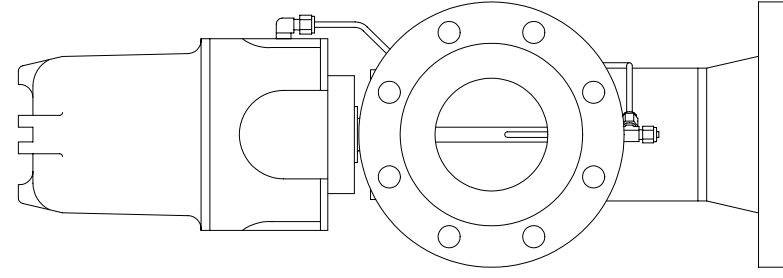

18 (457)
RECOMMENDED MINIMUM
CLEARANCE FOR ACCESS

0.75-14 NPT
REDUCING BUSHING (SUPPLIED)

- NOTES:
 1 WEIGHT: 67 LBS (30kg)
 2 ALL DIMENSIONS GIVEN IN INCHES
 MILLIMETER DIMENSIONS SHOWN IN ()

 PHASE DYNAMICS, INC RICHARDSON, TEXAS		
TITLE INSTALLATION 4 INCH L CONFIG CLASS 150 RF FLANGE		
SIZE	DWG NO.	DATE
C	0070-00144-000	02/05/99
REV	© PHASE DYNAMICS, INC.	
A		